

# VitrA

Sento  
Kids Collection







VitruA

We progressively invest in essentially  
human spaces - the bathrooms.



### **The complete bathroom**

Exploring physical and emotional needs, Vitra invests in design to produce every essential element in the bathroom.



### **It's all about inspiration**

It all begins with questions posed by the design discipline to understand needs, desires and choices. Designed by Vitra, an extraordinary wealth of attractive combinations help satisfy these needs and desires.



### **High powered perfection**

Seven cutting-edge factories and plants in Turkey and Russia create sophisticated designs and maintain extremely high standards whilst progressively reducing Vitra's ecological footprint.



### **Collaboration with designers**

Vitra works with acclaimed industrial designers from around the world. Not only does the collaboration with these top talents improve product functionality, but it also introduces an entirely original range.



### **Vitra across the world**

Bathroom designs greet customers around the world through 2000 sales points in over 75 countries, including 150 exclusive Vitra showrooms in Istanbul, London, Cologne, Moscow, Dubai, Mumbai, Delhi, and other major cities.



### **Technology lights up the future**

The Vitra Innovation Centre serves as the headquarters of the brand's R&D activities with a strong engineering team, leading the bathroom industry with new solutions and technologies.



### **Improved personal hygiene**

Vitra's continuous research into human health introduces new technologies for improved hygiene in the bathroom. These solutions raise the personal hygiene experience to a new level.



### **A pledge to the future**

Vitra embraces Blue Life, a set of guidelines devised to mitigate our impact on the environment, and is held as a production, design and management philosophy.

**Sento**

**Kids Collection**

bathroom solutions  
for new beginners



## Bathroom and children

Most modern parenting methods focus on the importance of helping children grow into independent and self-sufficient individuals. The design of children's environment, accordingly, includes objects in dimensions and weights suitable for their use. The aim is to enable children to move on their own without needing adult assistance.



Toilet training is one of the foundation stones of children's development. Successful toilet training in early childhood is understood to have a major influence on their psychosocial development; similarly, children who manage without adult assistance are generally more independent and self-assured.





The greatest responsibility for adults is to make this process as easy and safe as possible. Innovative and practical equipment to facilitate training is essential in order to safeguard children from potential harm as well as eliminate any obstacles.

Toilet training coincides with a period of motor development and learning by trial and error. Given that children's immune systems have yet to mature, it is crucial for their bathroom equipment to conform to the highest standards of hygiene.

# Psychological effects of comfort in the toilet

Ece Göç  
Clinical psychologist and psychiatrist  
Bilgen Therapy Institute

Feelings of adequacy today are usually connected with childhood experiences. Children who were starved of attention, love, praise, or responsibility grow into adults who frequently say, "I'm not good enough." or "I'm useless." Self-examination is another outcome. Conversely, the opposite also hold true: excessive attention, love, praise, and responsibility can often have a damaging effect. The most practical way of finding the balance is to firstly explain the responsibilities appropriate to their age at the right time, and then to take a step back and monitor the children discreetly.

It is very important for children to see to their personal care without needing an adult's help or guidance between the ages of three and six. These are lifetime skills that will also have an impact on other areas of development, which explains why systematic and correct training in personal care skills is so beneficial. Society at large has as much of a duty as the family to train children in personal care, dressing and undressing, awareness of healthy eating, an understanding of the rules of resting, and safeguarding oneself from accidents and dangers.

# 4 conditions for self-confidence

Imparting a sense of self-sufficiency as children are trained in hygiene and toileting, so essential to a healthy life, plays a major role in instilling these skills. Adults who stand as good role models monitor these behaviours and offer guidance when necessary, thereby speeding up the development and adoption of these skills. Support from society is also needed in helping children develop sensitivity to their bodies, their bodily functions, the importance of these skills, toilet etc. training and making sure they are competent in these areas.

The spatial characteristics of two areas at school and in society are equally important: toilets and bathrooms. A safe and comfortable environment will help children feel secure. In summary, environments that help children feel safe will have a positive impact on their personal development and relationships with their own selves.

## **Patience and kindness are crucial**

Research reveals the importance of personal care skill training methods in how well children adapt at school and in the wide world. Encouragement and support are the two key elements in these procedures. Children thus trained also develop self-sufficiency skills simultaneously.

### **1. Choosing the right toilet:**

If their feet touch the floor when they are seated on the toilet, children feel more comfortable, and are happier to 'go' to the toilet. They also feel more confident.

### **2. Patience:**

As every child has a different rate of development, it is important to choose the right time for that particular child for toilet training. This will help develop skills better and will also teach about patience for time spent in the toilet.

### **3. Practice:**

Allowing children to practise as much as they need and creating suitable conditions will increase their willingness to develop their personal care skills.

### **4. Privacy and availability:**

As valuable it is to monitor the process, it is equally beneficial to provide privacy in an entertaining way for the children in order to bolster their psychology.

## **--> So, where do we start?**

Like everything parents teach their children, training in toilet hygiene and personal care is crucial to establish correct habits. These habits are some of the sine qua nons of healthy development.



A comprehensive knowledge of toilet hygiene and personal care will, first and foremost, give children control. Children's own responsibility starts where the parents' duty ends. A grasp of these responsibilities requires motivation, keeping their current condition in mind (age, height, sex, emotional-social and personal development), and that is only through creating the physical conditions essential for children to develop their bodily and mental awareness.

These physical conditions will help raise children's awareness of their bodies and their five senses. Awareness positioned in daily life will actually serve the self, enabling detection of personal needs and thereby seeing to those needs adequately.

### **Personal care motivation for children**

- Children past infancy and early toddlerhood (0-3 years) are considered to be ready for toilet training. It is important for them to have got used to the toilet. Reinforcing this sense of familiarity is directly related to how safe they feel when they do go the toilet.
- Sitting on a WC that is the right height, which means keeping their feet on the ground, will not only help them feel supported by the floor when the bowel movement begins, but also allay any potential fears.
- Arm rests can offer additional ergonomic support when a child is struggling to pass stool and thereby help with the willingness to go.
- The diameter of the seat, feet touching the floor and arm rest support will all help with the recognition of the relationship between sitting on the toilet and pooing. This process will also assist with the child's awareness and knowledge of his/her own body.
- Flushing the loo after pooing will show the child where it goes, thereby eliminating any related uncertainty. Making the act of flushing fun helps to combat anxiety and fear. To this end, the right sized button (or similar) for the flushing mechanism would be helpful. This will also lay the groundwork for an introduction to the rules of hygiene.
- Teaching about washing hands and getting dressed again will help develop self-care skills.
- Washing hands is one of the first actions to teach pre-school children. This early learning habit will make sure they will wash their hands before eating and after going to the toilet, and it is vital to teach the correct technique. The more experience children have in washing their hands on their own, the more ingrained this behaviour will be. Washbasins and taps suitable to their physical development will prove to be invaluable in this respect.

- Concerns for privacy recommend a parent of the same sex as the child in carrying out personal care. It is possible, however, that children can look after their own personal care in privacy, provided bathrooms designed with their physical and emotional circumstances in mind.

### **Important points**

- Materials that appeal to children will give them a sense of belonging to that space.
- Use of safe materials wherever children may touch in the bathroom will prevent potential harm.
- Sitting down on the toilet, regardless of sex, is important for physiology.
- Raising awareness of the importance of flushing after going to the toilet is crucial as a social rule, as a show of respect and sense of responsibility.
- Washbasins set at the appropriate height and dimensions for children to wash their hands, preferably with liquid soap, rubbing for at least 20 seconds, will help develop their self-care skills as well as confidence that they can do it themselves.









## Ergonomic design, perfect bathrooms for children

The VitrA Sento Kids Collection focuses on toilet use at two main milestones in the personal development of children: three to five and five to six years. Age, sex, height, weight and knee heights of children between the ages of three to five and five to six were taken into account as their toilet behaviours were observed.

Developed by the VitrA Innovation Centre Ergonomics Laboratory engineers, the Sento Kids Collection is the result of intense research. Specially designed products for these periods aim to transform the toilet experience into a natural process.



# 4 ergonomic features that make Sento Kids Collection perfect for children

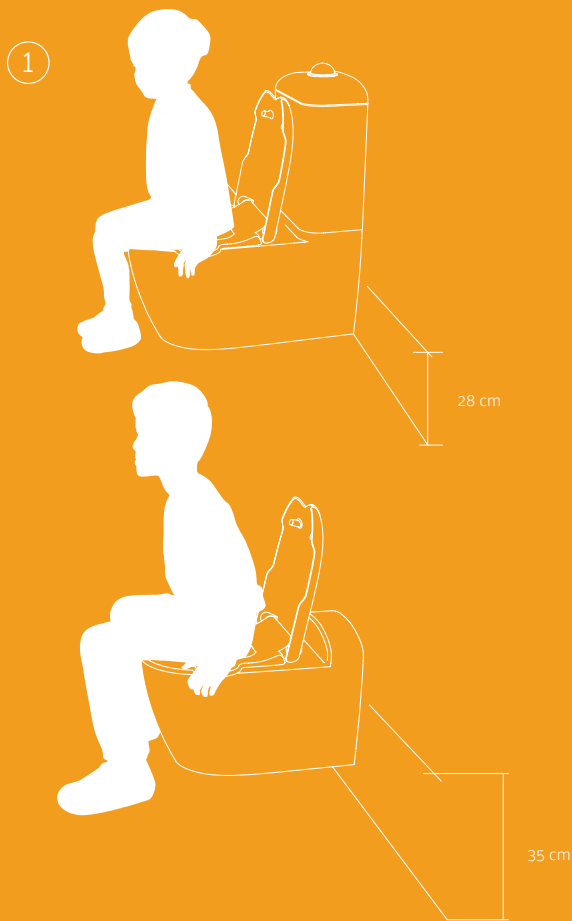

## 1. Children placing their feet on the floor

This priority for the Ergonomics Laboratory guided optimum heights: floor-standing and close-coupled WC pans of 28cm for three-to-four-year-olds, and wall-hung WC pans 35cm high for five-to-six-year-olds.

## 2. Comfort and safety to hand

Observations during ergonomic tests showed that children liked to grab the sides of the seat as they sat, and as they were trying to get up. Grab 'handles' were incorporated into the sides of the seat and an extra grab lip was added to the lid to make it easier for children to lift it.

3

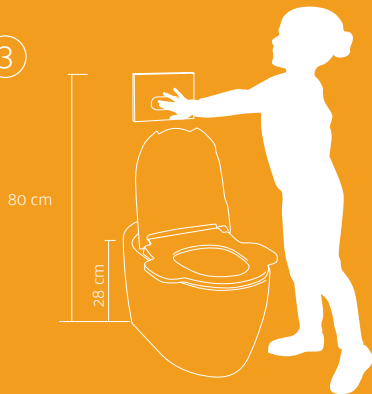

4

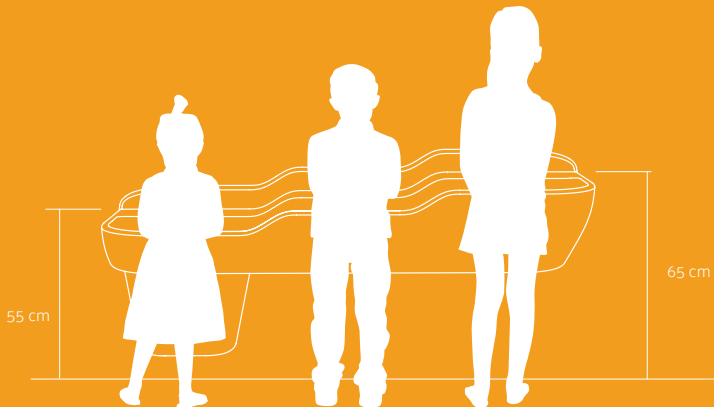
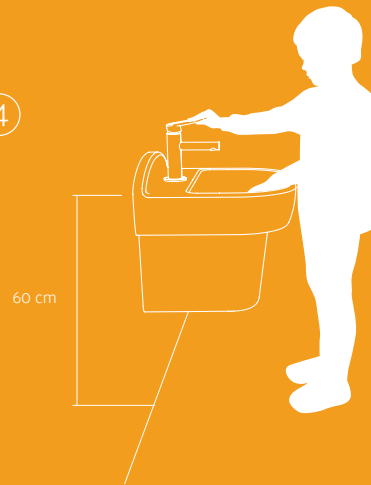

### 3. Accessibility in the bathroom

One area of testing concerned the height of the control panel. Installing a panel compatible with existing concealed Vitra cisterns at between 75 and 85cm aims to ease access for three-year-olds. The design of the large, single-press button enables easy access for children. A triple washbasin suitable for use by children between three and six aims to offer easy access to handwashing facilities.

### 4. Easy-to-operate handle

Another area of testing was the tap handle. Various grips were tested to determine the ideal operating options, resulting in the design of the Sento Kids handle that minimises the risk of little fingers getting caught.





## Colours and designs to appeal to children

Sento Kids Collection is designed to create bathrooms where children enjoy to be in. Designs and colours that will suit their colourful worlds await for children.











## Custom bathrooms for every child

### **Colourful design**

The colour palette of the Sento Kids Collection was chosen to encourage children to feel they belong in the bathroom, an environment they can use safely. A range of colours free of 'gender codes' offer versatility in design and were chosen to focus on the senses of, and to support the development of, specific age groups.

### **Different colours and dimensions**

Children's physical characteristics and needs established by ergonomic tests guided the design of a range of WC pans and washbasins at different heights. The collection aims to motivate use with dimensions, shapes and colours designed to appeal to children.

### **Design versatility for the professional**

The Sento Kids Collection offers great design versatility for professionals in combining a choice of colours and dimensions as well as heights for different age groups.

This feature not only enables designing with single, double or triple units in a variety of sizes, but also encourages children to wash hands together and to support one another in a fun atmosphere.

# Nursery and primary school design principles

Hasan Çalışlar  
MSc. Architect, Partner  
Erginoğlu & Çalışlar Architects

Straightforward as it might appear at first sight, nursery and primary school design demands attention to fine detail. The space and physical environment you create will establish the earliest visual images in the child's mind, as the ages between three and six is the period when children start to accumulate memories. Their first steps into physical exploration and use of space are taken – besides home and a couple of public spaces – at the nursery or primary school. The effects of this experience is bound to have an impact on the development of lifelong standards. This places a great deal of responsibility on the designer.

The single greatest element in pre-school education institutions is the creation of a physical environment at a scale where children can feel comfortable. It is important for this environment to be 'heimlich' as Freud would have said, that is, private, inside a comfort zone; somewhere familiar, as well as inviting new discoveries and different experiences. It should be cosy and equally encouraging.

One of the most critical areas in education institutions is wet areas. This importance is compounded by several factors, including the first time away from the family, toilet training, and sharing that experience with children at various stages – some more advanced, others less so.

It is essential for children to reach the toilet easily and settle comfortably on the seat. Grip handles on either side will help. This seated position is better for the abdominal muscles to contract and ease the bowel movement. Children will also feel more secure, and find wiping themselves easier afterwards.

That growth rates vary between the ages of five and six explains the need for a range of dimensions. Children feel reassured in the presence of sanitaryware designed for them to use unassisted, appropriate for their size. The importance of toilet training to self-confidence is indisputable, and due care taken in designing relevant details will definitely be helpful.



*MTK International School in the name of Heydar Aliyev*  
Photography : Cemal Emden

During the spatial planning stage in the design of wet areas, architects must factor in the users' age ranges. Furniture selection, similarly, must focus on well-lit shelves and cupboards where toothbrushes can be lined up and stay hygienically clean; all materials used must be easy to clean and durable in gently rounded shapes, with no sharp edges or pointy corners.

As their personal care skills are not yet fully developed, children in the 3-4 age group will need support, which necessitates designing toilets without doors. In contrast, the 5-6 age group, becoming more aware of their bodies, need more privacy. This is not so much about embarrassment before the opposite sex as to prevent attaching a sense of shame to 'going to the toilet'.





## Safe bathrooms for children

The majority of accidents at home occur in the bathroom and kitchen. Wet, and consequently slippery floors make bathrooms the most risky area of all. With skeletal and muscular structures much more delicate than those of adults, children's safety in the bathroom is paramount.





## Details for maximum safety

The Sento Kids Collection aims to minimise accidents in the bathroom. Tests on children's physical condition and use of bathrooms carried out at the VitrA Innovation Centre directed the design of Sento Kids to provide a physically safe environment as well as an educational and hygienic one.

Rounded corners and flexible materials used in washbasins and WC pans intend to transform bathrooms and toilets into spaces that banish injury.







### Silent WC Seat

Soft-Closing WC Seat which closes itself softly is both silent and safe for children. Thanks to its special mechanism, it prevents the risk of getting hands caught. The special hygienic material simplifies cleaning in bathrooms and toilets, as well as eliminating the need to replace the seat frequently.



### Softened lines

All sharp lines are softened to eliminate the risk of injury from bumps or falls.



### Hidden plumbing

The recommended half pedestals for the washbasins conceal the plumbing, including the U-bend, to prevent access by children.



### Maximum safety

Soft silicon guards at the edges of accessories offer extra safety.





## Healthy bathrooms for children

Bathroom can harbour dirt and bacteria that could cause contagious diseases in adults and pose an even greater threat to children, whose immune systems are much more vulnerable. School toilets, in particular, are one of the top causes of contagious diseases amongst children. It is vital for children's health, therefore, that the highest hygienic standards in public toilets in places such as schools, shopping centres and clinics are maintained.

With its design and technology, the Sento Kids Collection prioritises children's right to a healthy toilet. Every item in the collection features clean, sleek and rounded lines; concealed installation gives dirt nowhere to hide, and makes cleaning easy.

Designed with innovative VitrA features, the Sento Kids Collection offers children clean and healthy toilets. The focused design approach delivers superior hygiene in children's toilets.





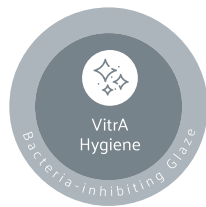

## VitrA Hygiene

### Bacteria-inhibiting ion technology

VitrA Hygiene coats all VitrA ceramic sanitaryware, a special glaze, which inhibits the growth of harmful bacteria by up to 99.9%.

By destroying the cellular structure of microorganisms that may contaminate and attempt to colonise the surface, the VitrA Hygiene glaze neutralises them.

VitrA Hygiene has been tested by national and international laboratories in accordance with global protocols such as ISO 22196, JIS Z 2801, ASTM E 3031-15, and TSE 13420, and proven to be effective against gram negative (*E. coli*) and gram positive (*S. aureus*) bacteria.

The VitrA Hygiene glaze coats all external and internal surfaces prior to firing in a process that ensures lifetime VitrA Hygiene protection for VitrA ceramic sanitary ware.

The chart compares the reduction in bacteria growth on standard ceramic sanitary ware with VitrA Hygiene.

**Fewer chemicals, better hygiene with VitrA Hygiene.**

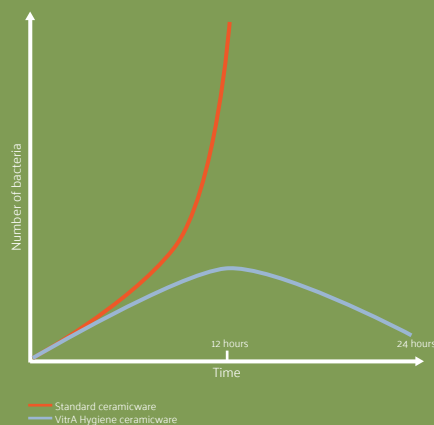







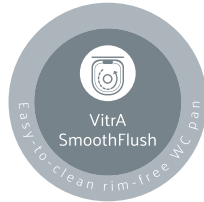

## VitrA SmoothFlush

### **Easy-to-clean rim-free WC pan**

VitrA SmoothFlush WC pans have no rims or openings that might harbour harmful bacteria or microorganisms. This makes VitrA SmoothFlush WC pans much easier to clean and offer maximum hygiene.



Rim-free WC pan



Standard WC pan



## Vitra Concealed Installation

### **Design that leaves no room for dirt**

The sleek design is one of several ideas that ensure lasting hygiene for the Vitra wall-hung WC. The recessed mounting detail and screws on the side surface of standard wall-hung toilets are hidden inside the chamber in Vitra wall-hung toilets. The concealed installation leaves no room for dust or dirt to accumulate, making the whole surface easy to clean.



## Technical information

The Sento Kids Collection offers a variety of washbasin types for specific- as well as mixed age groups. Every item in the collection is suitable for different combinations to suit design approaches or local requirements. The collection is comprehensive enough to eliminate the need for external accessories.



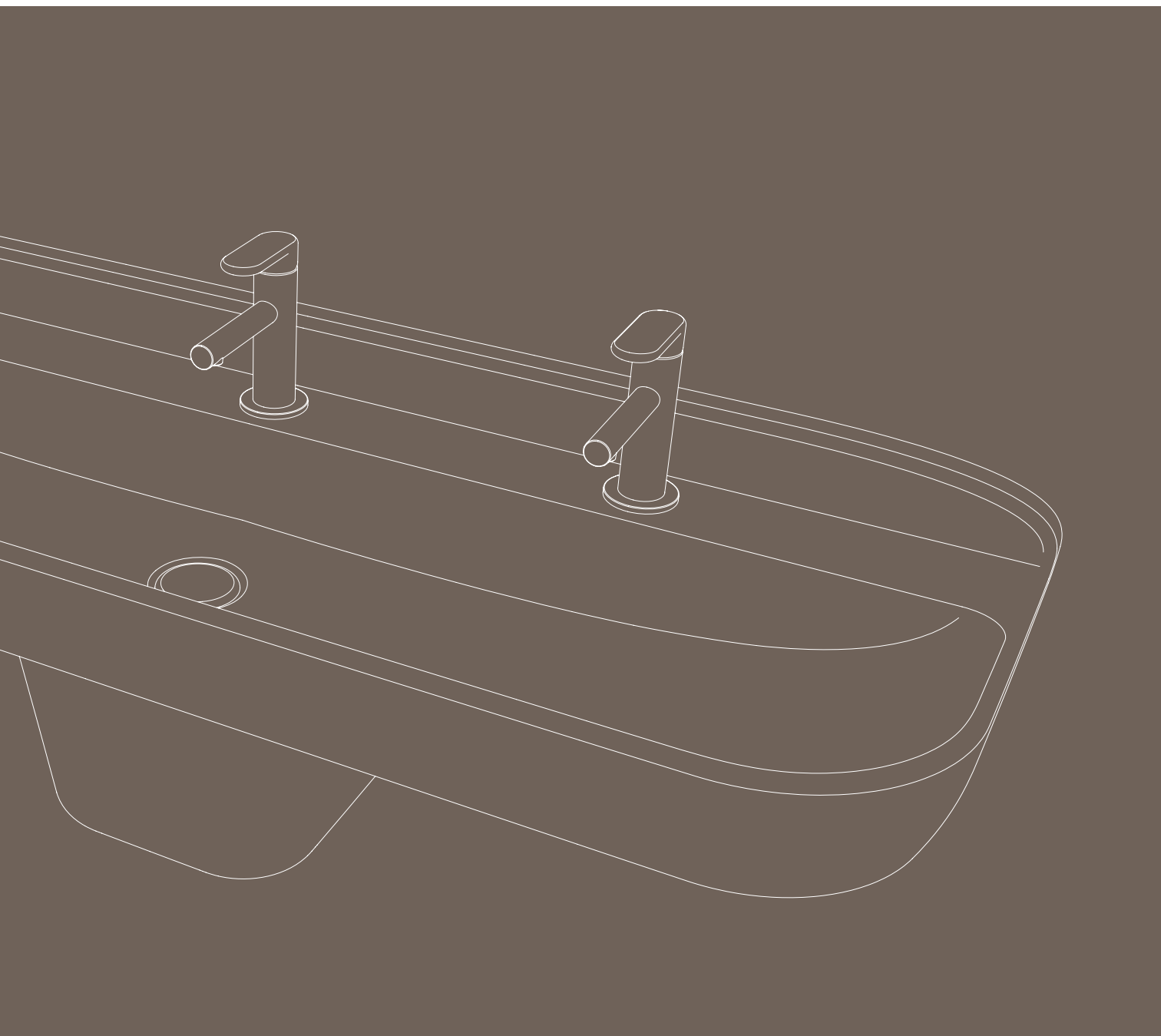

## Washbasins



Washbasin, 45 cm  
White

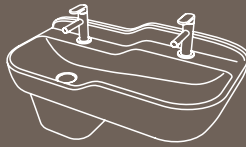

Double washbasin, 85 cm  
Two layers, white

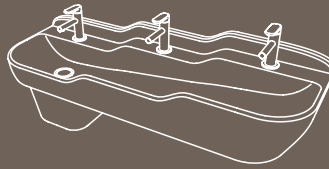

Triple washbasin, 125 cm  
Three layers, white

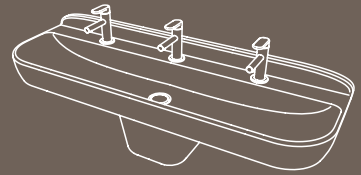

Triple washbasin, 125 cm  
One layer, white

## WCs



Floor-standing  
single WC pan, 50 cm  
White



Wall-hung WC pan 47 cm  
White

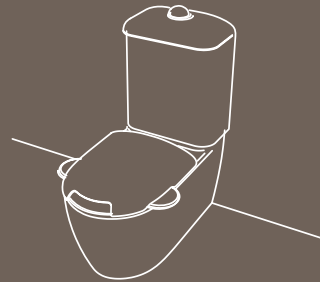

Close-coupled WC pan, 57 cm  
Back to wall, white

## WC Seat



WC seat  
Yellow - Bottom seat  
Green - Lid

## Control Panel



Control panel  
White - Body  
Blue - Button

## Taps



Basin mixer  
Yellow - Handle & rosette  
Green - Body



Basin mixer  
Yellow - Handle & rosette  
Chrome - Body



Photocell basin mixer  
Green - Cover  
Chrome - Body

## Mirrors



Mirror, 20 cm  
Orange



Mirror, 40 cm  
Orange

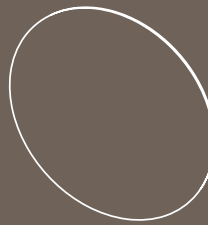

Mirror, 60 cm  
Orange

## Accessories



WC brush holder  
Orange



Liquid soap dispenser holder  
Orange

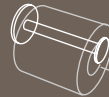

Roll holder  
Orange

# Product assembly schemes by age groups

3-4 years

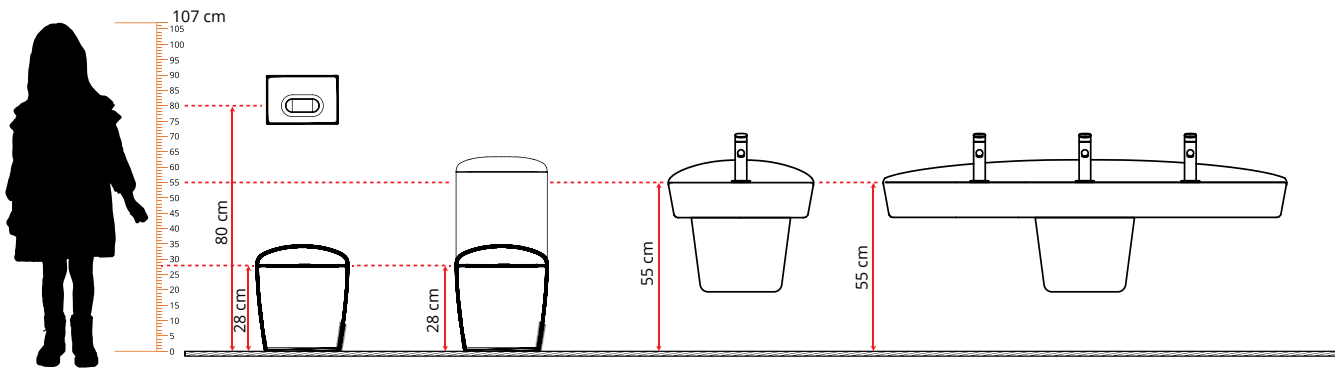

4-5 years

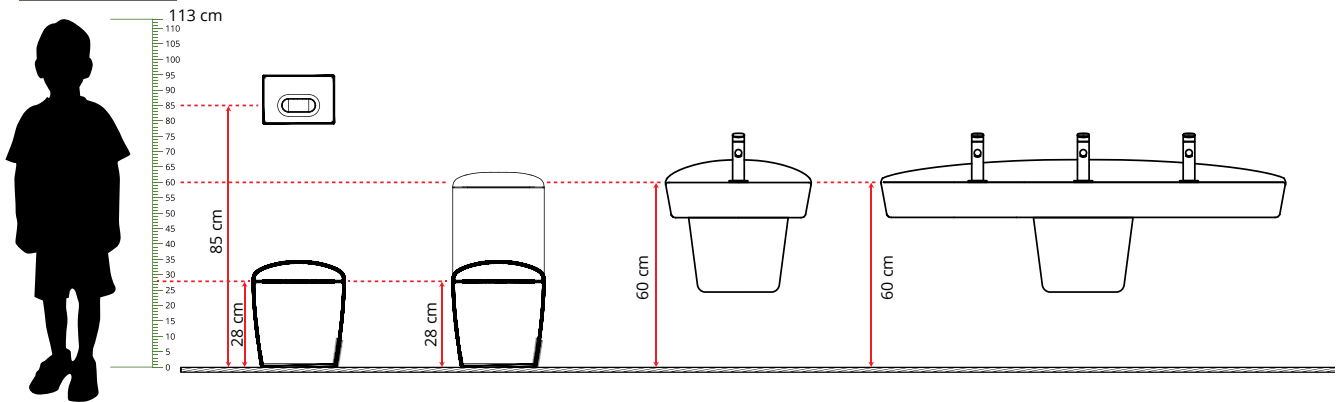



### 5-6 years

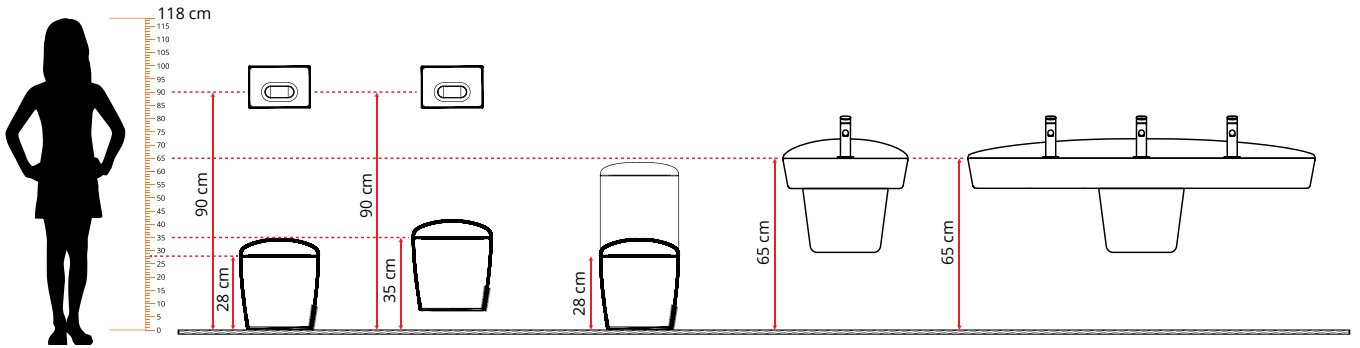

### 3-6 years

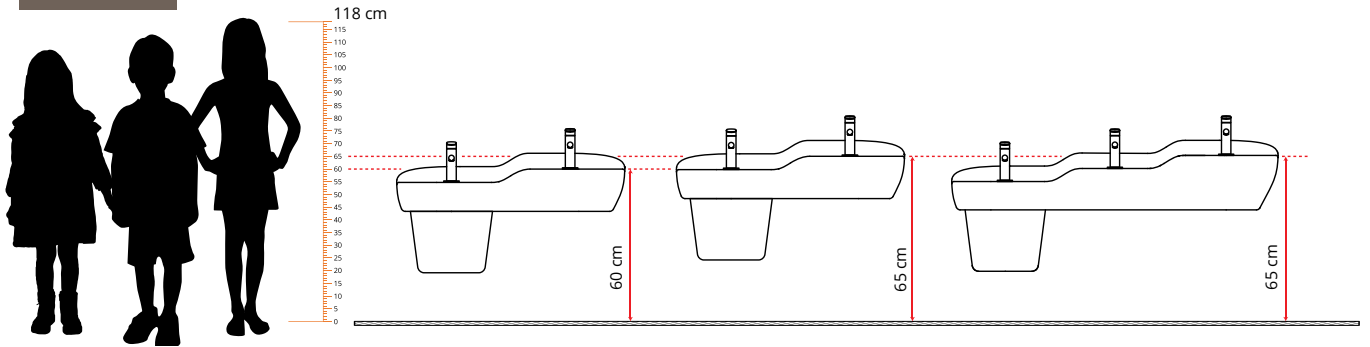



### Washbasin, 45 cm

**Code:**

7350B003-0041 With tap hole, without overflow hole  
 7350B003-0001 With tap hole, with overflow hole

**Compatible products:**

Half pedestal Ceramic cover syphon cap

|       |               |               |
|-------|---------------|---------------|
| Blue  | 7354B021-0156 | 6392L021-0159 |
| White | 7354B003-0156 | 6392L003-0159 |

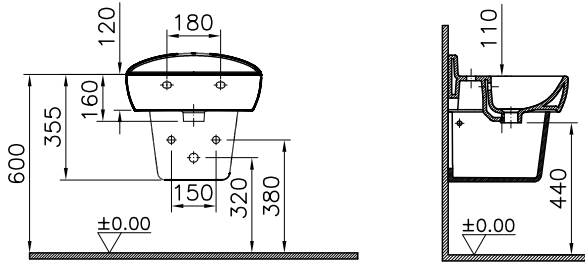
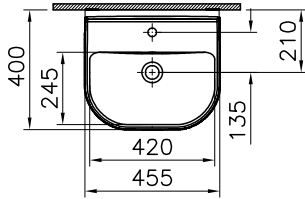

### Double washbasin, two layers, 85 cm

**Code:**

7351B003-1739 With two tap holes, without overflow hole  
 7351B003-1740 With two tap holes, with overflow hole

**Compatible products:**

Half pedestal Ceramic cover syphon cap

|       |               |               |
|-------|---------------|---------------|
| Blue  | 7354B021-0156 | 6392L021-0159 |
| White | 7354B003-0156 | 6392L003-0159 |

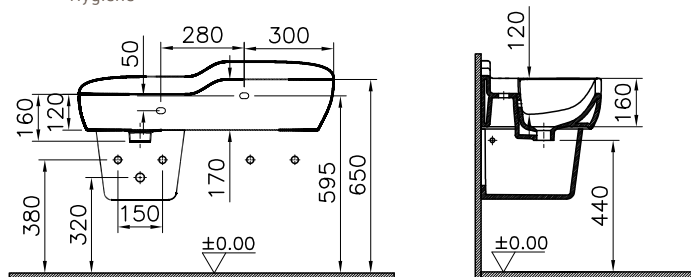
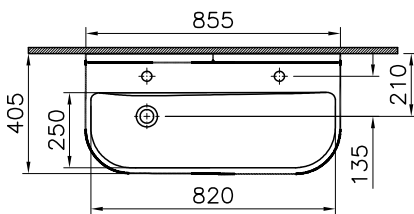



### Triple washbasin, three layers, 125 cm

**Code:**

7352B003-1741 With three tap holes, without overflow hole  
 7352B003-1742 With three tap holes, with overflow hole

**Compatible products:**

Half pedestal Ceramic cover syphon cap

|       |               |               |
|-------|---------------|---------------|
| Blue  | 7354B021-0156 | 6392L021-0159 |
| White | 7354B003-0156 | 6392L003-0159 |

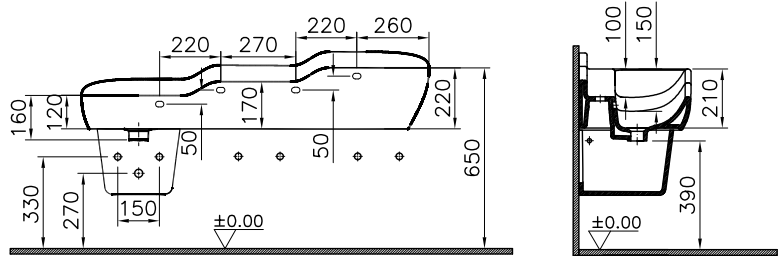
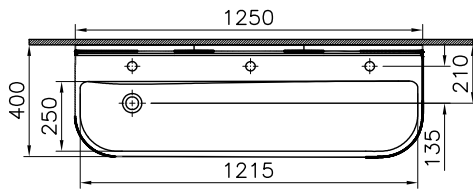

### Triple washbasin, one layer, 125 cm

**Code:**

7353B003-1741 With three tap holes, without overflow hole  
 7353B003-1742 With three tap holes, with overflow hole

**Compatible products:**

Half pedestal Ceramic cover syphon cap

|       |               |               |
|-------|---------------|---------------|
| Blue  | 7354B021-0156 | 6392L021-0159 |
| White | 7354B003-0156 | 6392L003-0159 |

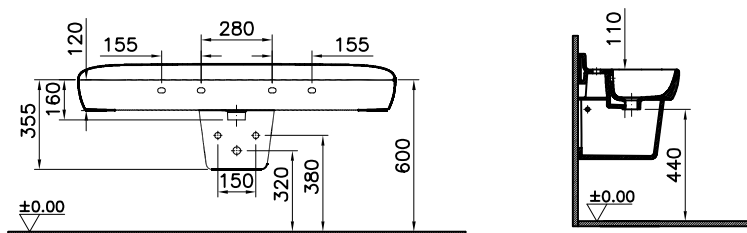
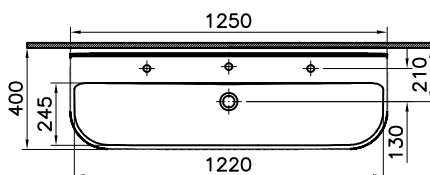



### Basin mixer

**Code:**

A42666, Chrome - Yellow  
 A4266646, Green - Yellow

Max. 5 L/min. flow rate

Installation without any additional tool

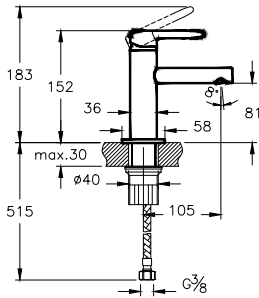

### Photocell basin mixer

**Code:**

A47188, Mains, chrome - green  
 A47187, Battery, chrome - green  
 A47199, Powerbox, chrome - green

After 60 seconds of continuous detection of an object, electronics automatically stop the water flow.

Single water inlet.

6V battery/6V DC mains connection.

Distance between faucet and beginning of washbasin bowl area must be max 70mm.

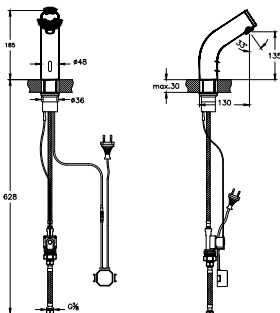



### Close-coupled WC pan, back-to-wall, 57 cm

**Code:**

7362B003-0585 WC pan  
 7363B003-0108 Cistern, bottom inlet  
 7363B003-5723 Cistern, bottom inlet (single flush cistern mechanism is included)

**Compatible products:**

330-3022 Single flush cistern mechanism  
 133 Kids WC Seat



VitrA Hygiene



VitrA Smoothflush

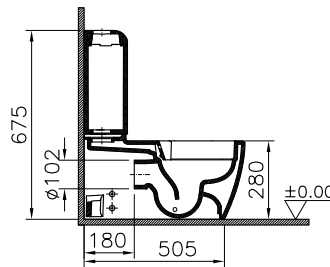
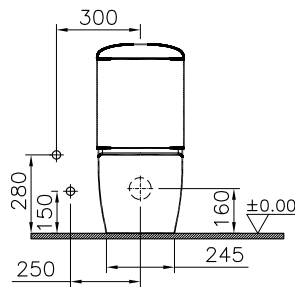
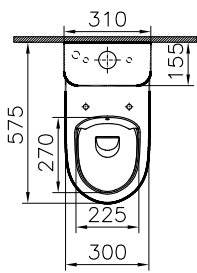

### Floorstanding single WC pan, 50 cm

**Code:**

7361B0003-0075

**Compatible products:**

133 Kids WC Seat



VitrA Hygiene



VitrA Smoothflush

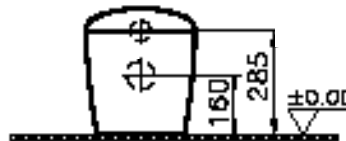
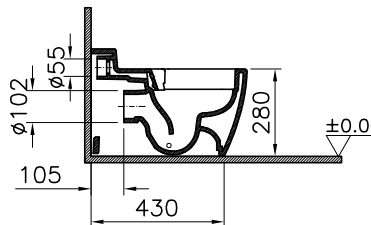
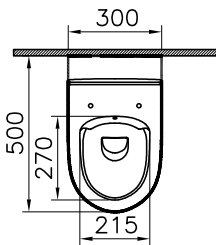



### Wall-hung WC pan, 47 cm

**Code:**

7360B003-0075

**Compatible products:**

133 Kids WC Seat



VitrA  
Hygiene



VitrA  
Concealed  
installation



VitrA  
Smoothflush

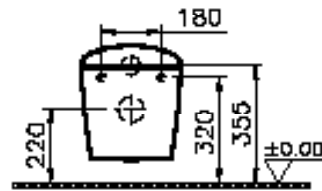
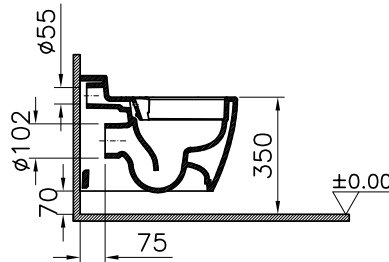
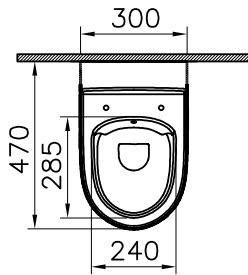

### Kids WC seat

Metal hinge, top fixing, soft-closing

**Code:**

133-100-009 Green-yellow, with orange supporter

133-101-009 Green-yellow, with white supporter

133-003-009 White, with white supporter



VitrA  
Hygiene

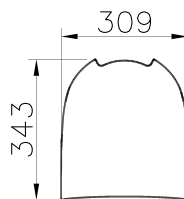
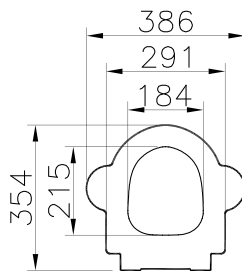



### Control panel

**Code:**  
740-2001

Mechanic control  
Single flush

**Compatible products:**  
Compatible with 742-XXXX-XX, 748-XXXX-XX and 750-XXXX-XX concealed cisterns.

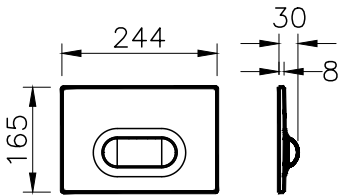

### Mirror

**Code:**  
65865 - 20cm  
65866 - 40cm  
65867 - 60cm

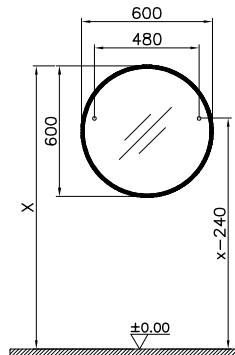
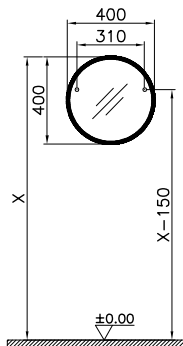
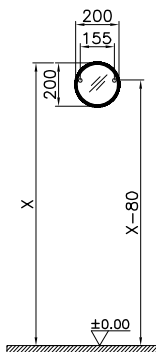



### WC brush holder, wall-mounted

**Code:**  
A4491667

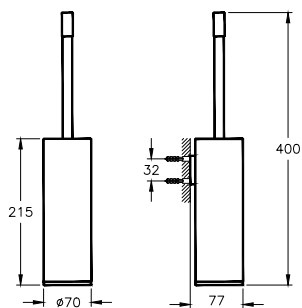

### Liquid soap dispenser holder, wall-mounted

**Code:**  
A4491567

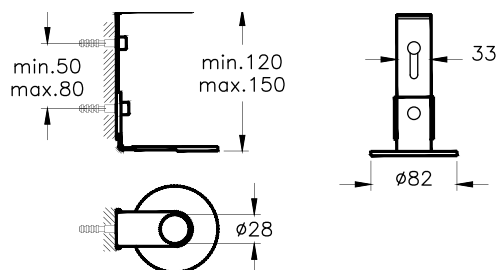



**Roll holder**

**Code:**  
A4491467

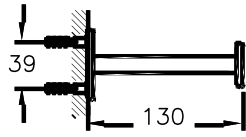
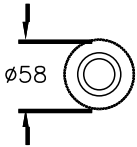

### **VitrA Turkey**

Büyükdere Cad. Ali Kaya Sok. No: 5  
Levent 34394 İstanbul, Turkey  
**Phone:** +(90 212) 350 80 00  
**Fax:** +(90 212) 350 84 45  
**www.vitra.com.tr**

### **VitrA UK**

Park 34 Collet Way,  
Didcot Oxon OX11 7WB, UK  
**Phone:** +(44 1235) 750 990  
**Fax:** +(44 1235) 750 985  
**www.vitra.co.uk**

### **VitrA Germany**

Agrippinawerft 24,  
50678 Cologne, Germany  
**Phone:** +49 (0) 221 / 27 73 68-0  
**Fax:** +49 (0) 221 / 27 73 68-500  
**www.vitra-bad.de**

### **VitrA France**

Z.I. Le Poirier - CS 80019  
F - 28132 Nogent Le Roi CEDEX, France  
**Phone:** +33 (0) 2 37 38 69 92  
**Fax:** +33 (0)2 37 51 43 94  
**www.vitra-bad.fr**

### **VitrA Italy**

Viale San Pietro 83  
41049 Sassuolo (Mo), Italy  
**Phone:** +39 0536 1818100  
**www.vitraglobal.com**

### **VitrA UAE**

Jumeirah Business Centre 5  
Unit 1006 No. W1 Jumeirah  
Lake Towers, Dubai, UAE  
**Phone:** +(971) 52-276-7386  
**Fax:** +(971) 4-457 2467  
**www.vitraglobal.com**

### **VitrA India**

B-102, Duro-lite House, Opp. SAB TV  
Building, New Link Road, Andheri (West),  
Mumbai 400053 India  
**Phone:** +(91) 22-6708 5000  
**www.vitraglobal.com**

### **VitrA Russia**

9, Varshavskoe Highway, Bldg.1  
Danilovskaya Manufactory  
Block 'Sitsevy', 4 Entr., 1st Floor  
Moscow 117105 Russia  
**Tel:** +7 (495) 221 76 11 (ext. 1101)  
**www.vitra-russia.ru**

### **VitrA International**

Büyükdere Cad. Ali Kaya Sok. No: 5  
Levent 34394 İstanbul, Turkey  
**Phone:** +(90 212) 350 80 00  
**Fax:** +(90 212) 350 84 45  
**www.vitraglobal.com**  
**export@vitra.com.tr**



